



SUB*ZERO

MODEL IC-36FI DESIGN GUIDE

REVISED 5/2016



Features and specifications are subject to change at any time without notice. Visit subzero.com/specs for the most up-to-date information.

Throughout this guide, dimensions may vary by $\pm 1/8"$ (3). Dimensions in parentheses are millimeters unless otherwise specified.

Integrated Refrigeration

With custom front panels and hardware, Sub-Zero invented integrated columns, tall and drawer models that disappear into the decor. Integrated units fit flush with other cabinets, making integrated refrigeration as practical and beautiful in the master suite, bar or theatre room as in the kitchen.

INTEGRATED COLUMN



Model IC-36FI

SPECIFICATIONS

Model IC-36FI

SPECIFICATIONS

INTERIOR CAPACITY	CU FT (L)
IC-36FI	20.0 (566)
SHIPPING WEIGHT	LB (KG)
IC-36FI	460 (209)

Overall Dimensions

MODEL IC-36FI

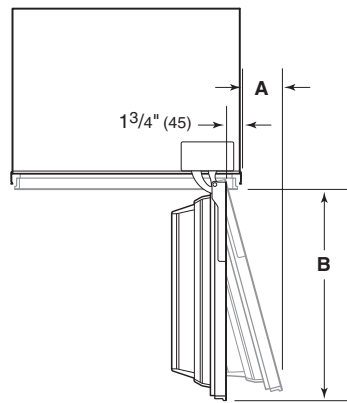
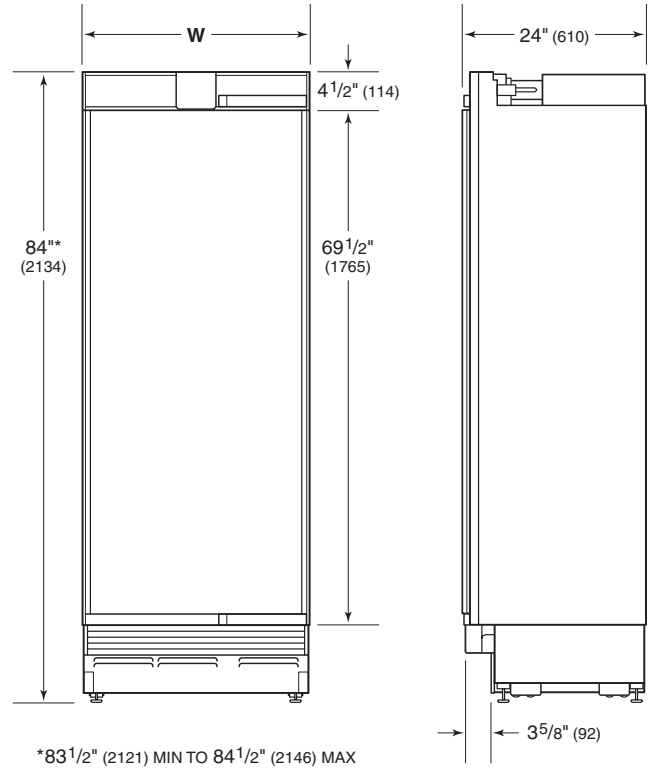

OVERALL DIMENSIONS	W	A	B
IC-36FI	36" (914)	7 1/4" (184)	34 1/2" (876)

IMPORTANT NOTE: Overall dimensions do not include panel or handle. Dimensions will vary with panel thickness.

Opening Dimensions

MODEL IC-36FI

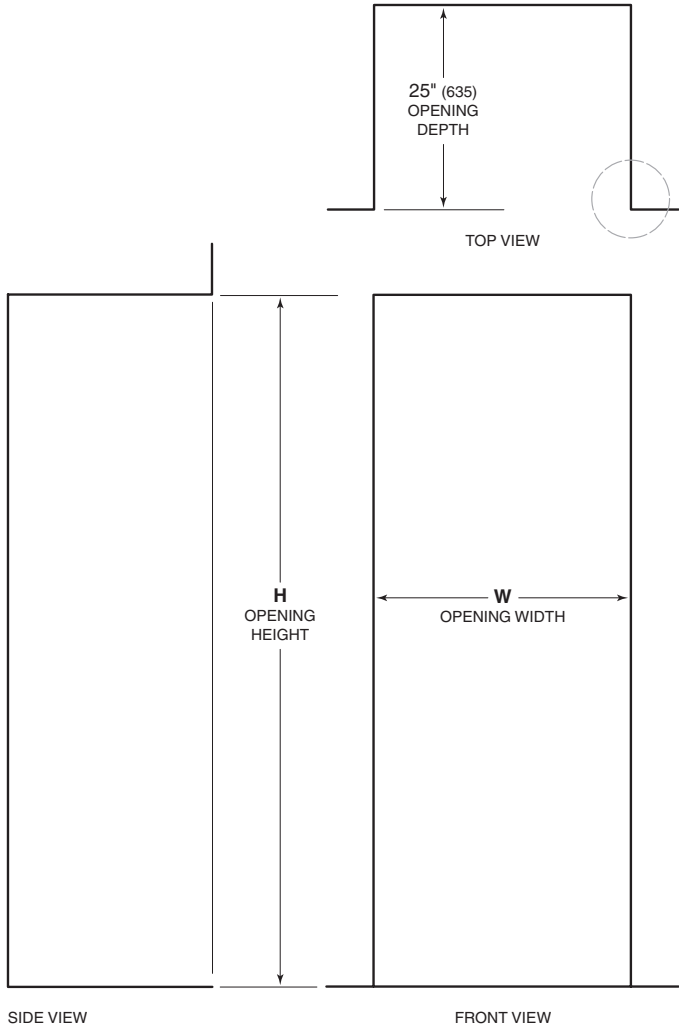

NOTE: 3 1/2" (89) finished returns will be visible and should be finished to match cabinetry.

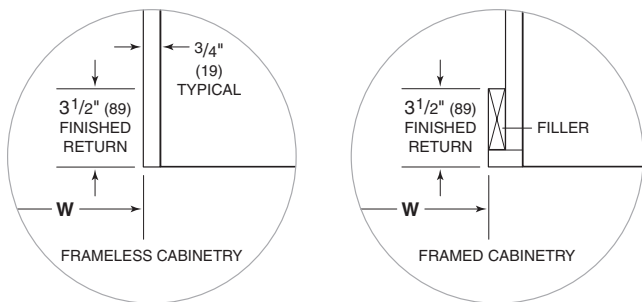

OPENING DIMENSIONS

	W	H
IC-36FI	36" (914)	84" (2134)

The depth of model IC-36FI is 24" (610). Allow for panel thickness when planning the finished opening depth. A minimum 3 1/2" (89) finished return is required on all sides of the opening. Framed cabinets will require additional finished filler material behind the face frame for a proper installation. Refer to the illustration.

DUAL INSTALLATION

When installing two units side by side in a dual installation, the opening width is the width of the two units added together. A dual installation kit will be required for this installation. If a dual installation kit is not specified, a minimum 2" (51) filler strip is required between units.

Dual installation kits are available through an authorized Sub-Zero dealer. For local dealer information, visit the find a showroom section of our website, subzero.com. For questions regarding the installation, call Sub-Zero customer care at 800-222-7820.

Electrical

The electrical supply must be located within the shaded area shown in the illustration and chart below. A separate circuit, servicing only this appliance is required. A ground fault circuit interrupter (GFCI) is not recommended and may cause interruption of operation.

The electrical outlet must be positioned with the grounding prong to the right of the thinner blades.

Installation must comply with all applicable electrical codes.

ELECTRICAL REQUIREMENTS

Electrical Supply	115 VAC, 60 Hz
Service	15 amp
Receptacle	3-prong grounding-type

ELECTRICAL SUPPLY LOCATION

A

IC-36FI	15 1/2" (394)
---------	---------------

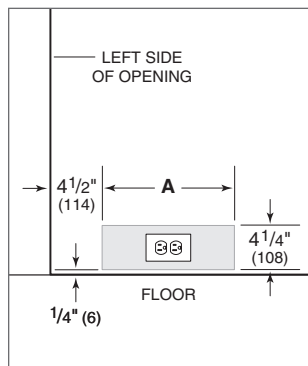

Electrical supply location.

Plumbing

The water supply line should be located within the shaded area shown in the illustration below. The water supply line should be connected to the house supply with an easily accessible shut-off valve. Do not use self-piercing valves. The water supply line must not interfere with installation of the anti-tip bracket.

A reverse osmosis system can be used provided there is constant water pressure of 35–120 psi (2.4–8.3 bar) supplied to the unit at all times. A copper line is not recommended for this application.

Installation must comply with all applicable plumbing codes.

PLUMBING REQUIREMENTS

Water Supply	1/4" OD copper, braided stainless steel or PEX tubing
Pressure	35–120 psi (2.4–8.3 bar)
Excess Line for Connection	36" (914)

WATER SUPPLY LOCATION

A

IC-36FI	9" (229)
---------	----------

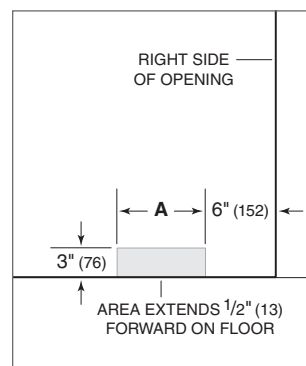

Water supply location.

Custom Panel

For model IC-36FI, a custom door panel and handle hardware must be provided. Refer to the panel requirements chart and typical panel dimensions.

The thickness of the custom panel can vary. A minimum $\frac{5}{8}$ " (16) thick panel is required, but the thickness can be increased provided it does not exceed the weight limit. The depth of model IC-36FI is 24" (610). Allow for panel thickness when planning the finished opening depth. Refer to the full-scale template at the end of this guide.

CAUTION

As reveals between cabinetry and the unit decrease, severe finger pinching can occur while door is closing.

Finish all sides of the custom panel. They will be visible when the door is open.

D-style handles are recommended. Door handles must be located near the edge of the panel opposite the hinge and should be centered top to bottom. Stainless steel tubular and pro handles are available through an authorized Sub-Zero dealer. For local dealer information, visit the find a showroom section of our website, subzero.com.

PANEL REQUIREMENTS

Max Panel Weight	75 lb (34 kg)
Min Panel Thickness	$\frac{5}{8}$ " (16)

TYPICAL PANEL DIMENSIONS

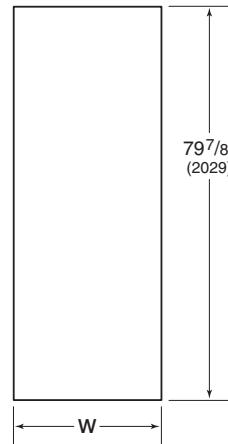

Model IC-36FI

Typical panel dimensions are based on an 84" (2134) finished height with a 4" (102) toe kick and $\frac{1}{8}$ " (3) reveals. Panel dimensions must be adjusted accordingly for all other installations. Refer to the illustration for panel height and the chart below for panel width.

PANEL WIDTH

	W
IC-36FI	$35\frac{3}{4}$ " (908)

DUAL INSTALLATION

For dual installations, refer to the illustration for panel height and the chart below for panel width.

PANEL WIDTH

	W
IC-36FI	$35\frac{13}{16}$ " (910)

Custom Panel

DOOR PANEL HEIGHT

The height of the custom door panel can extend beyond the typical panel height, provided it does not exceed the weight limit. Refer to the illustration below.

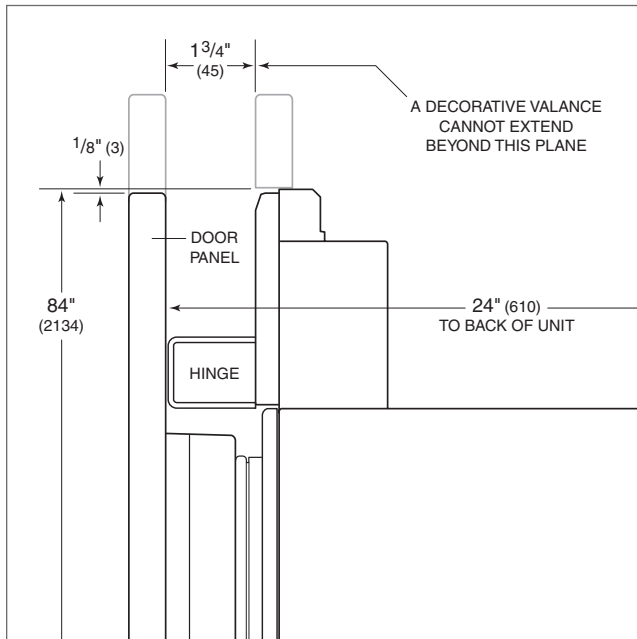

Upper valance (side view).

TOE KICK CLEARANCE

The height of the toe kick area can extend beyond the typical toe kick height, provided it does not exceed the dimensions in the illustration below. Toe kick heights from 2" (51) to 3 7/8" (98) require a reduced toe kick accessory available through an authorized Sub-Zero dealer. For local dealer information, visit the find a showroom section of our website, subzero.com. For questions regarding the installation, call Sub-Zero customer care at 800-222-7820.

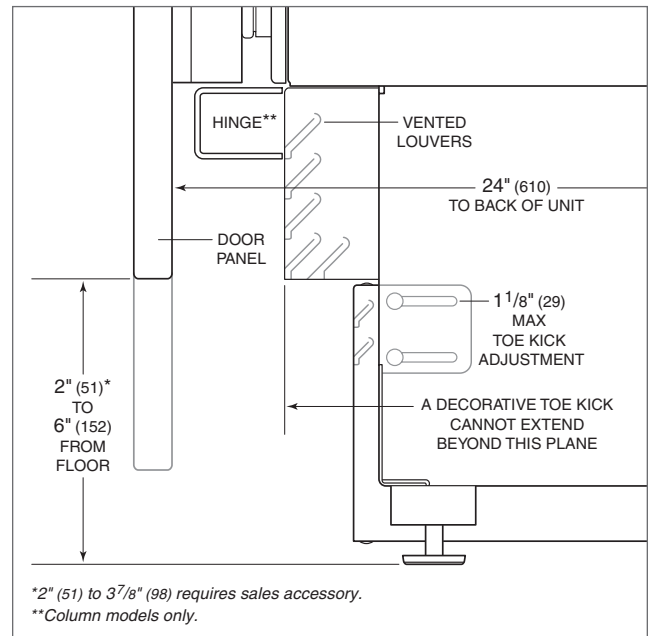

*2" (51) to 3 7/8" (98) requires sales accessory.
 **Column models only.

Toe kick (side view).

Standard Handles

Optional stainless steel tubular and pro handles are available through an authorized Sub-Zero dealer. For local dealer information, visit the find a showroom section of our website, subzero.com.

Refer to the chart below for standard handle lengths for model IC-36FI.

HANDLE LENGTH

Tubular	50 ^{1/8} " (1273)
Pro	48 ^{3/8} " (1229)

Maximum Door Opening

FULL-SCALE TEMPLATE

As the panel width and/or depth increases, so does the potential for panel interference. Interference may be minimized by utilizing the 90° door stop.

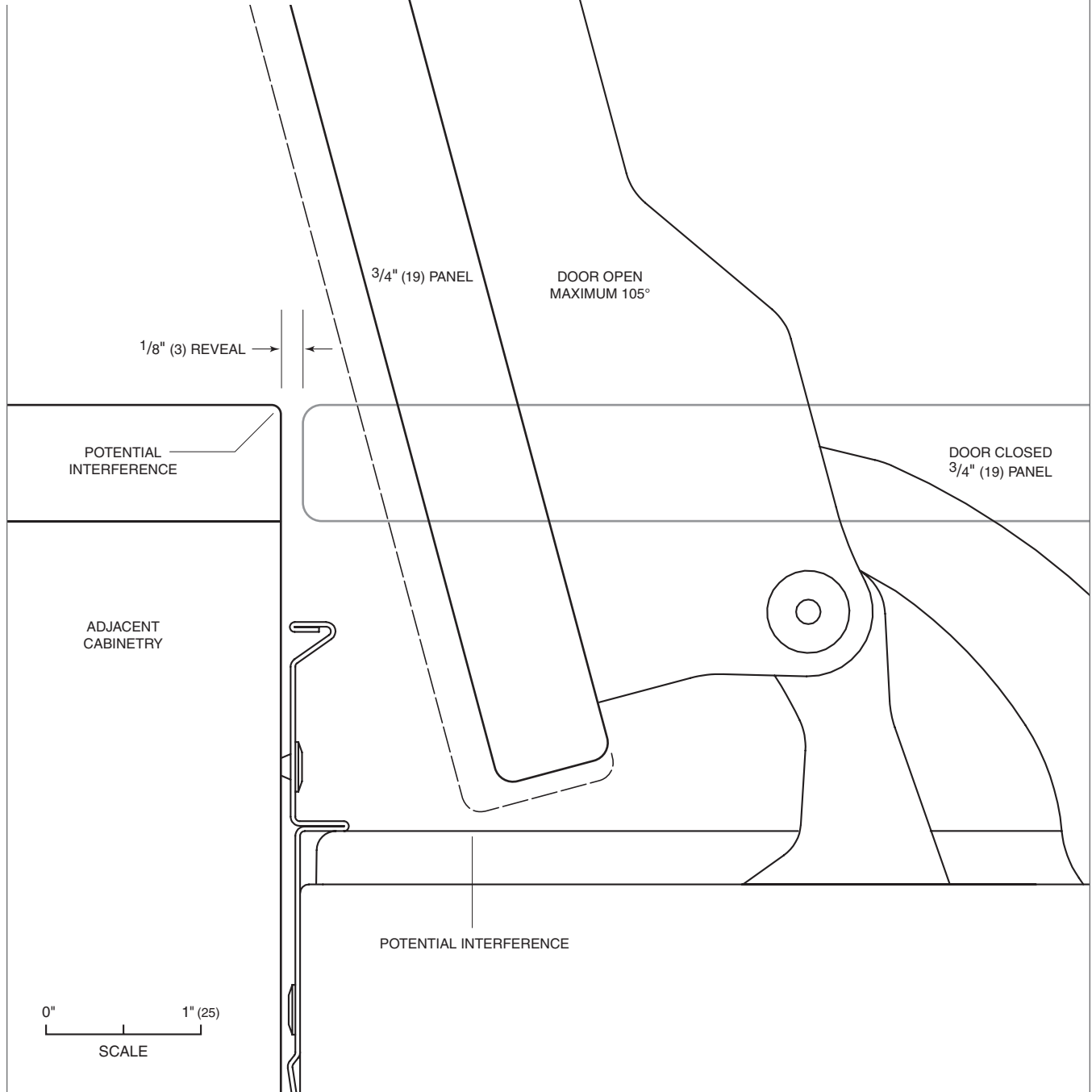

Maximum door opening (top view).

Sub-Zero Residential Limited Warranty

FOR RESIDENTIAL USE

FULL TWO YEAR WARRANTY*

For two years from the date of original installation, this Sub-Zero product warranty covers all parts and labor to repair or replace, under normal residential use, any part of the product that proves to be defective in materials or workmanship. All service provided by Sub-Zero under the above warranty must be performed by Sub-Zero factory certified service, unless otherwise specified by Sub-Zero, Inc. Service will be provided during normal business hours.

FULL FIVE YEAR SEALED SYSTEM WARRANTY

For five years from the date of original installation, this Sub-Zero product warranty covers all parts and labor to repair or replace, under normal residential use, these parts that prove to be defective in materials or workmanship: compressor, condenser, evaporator, drier and all connecting tubing. All service provided by Sub-Zero under the above warranty must be performed by Sub-Zero factory certified service, unless otherwise specified by Sub-Zero, Inc. Service will be provided during normal business hours.

LIMITED TWELVE YEAR SEALED SYSTEM WARRANTY

For twelve years from the date of original installation, Sub-Zero will repair or replace the following parts that prove to be defective in materials or workmanship: compressor, condenser, evaporator, drier and all connecting tubing. If the owner uses Sub-Zero factory certified service, the service provider will repair or replace these parts with the owner paying for all other costs, including labor. If the owner uses non-certified service, the owner must contact Sub-Zero, Inc. (using the information below) to receive repaired or replacement parts. Sub-Zero will not reimburse the owner for parts purchased from non-certified service or other sources.

TERMS APPLICABLE TO EACH WARRANTY

The warranty applies only to products installed for normal residential use. The warranty applies only to products installed in any one of the fifty states of the United States, the District of Columbia or the ten provinces of Canada. This warranty does not cover any parts or labor to correct any defect caused by negligence, accident or improper use, maintenance, installation, service or repair.

THE REMEDIES DESCRIBED ABOVE FOR EACH WARRANTY ARE THE ONLY ONES THAT SUB-ZERO, INC. WILL PROVIDE, EITHER UNDER THIS WARRANTY OR UNDER ANY WARRANTY ARISING BY OPERATION OF LAW. SUB-ZERO, INC. WILL NOT BE RESPONSIBLE FOR ANY CONSEQUENTIAL OR INCIDENTAL DAMAGES ARISING FROM THE BREACH OF THIS WARRANTY OR ANY OTHER WARRANTY, WHETHER EXPRESS, IMPLIED OR STATUTORY.

Some states do not allow the exclusion or limitation of incidental or consequential damages, so the above limitation or exclusion may not apply to you. This warranty gives you specific legal rights and you may also have other legal rights that vary from state to state.

To receive parts and/or service and the name of Sub-Zero factory certified service nearest you, contact Sub-Zero, Inc., P.O. Box 44848, Madison, WI 53744; check the contact & support section of our website, subzero.com, email us at customerservice@subzero.com or call 800-222-7820.

*Stainless steel (doors, panels, handles, product frames and interior surfaces) are covered by a limited 60-day parts and labor warranty for cosmetic defects.

*Replacement water filters and air purification cartridges are not covered by the product warranty.





SUB-ZERO, INC. P.O. BOX 44848 MADISON, WI 53744 SUBZERO.COM 800.222.7820